

OPERATION MANUAL
CHAMP 3529 RB

IMPORTANT SAFETY INSTRUCTIONS



WARNING: Failure to observe these instructions can cause personal injury to machine operator or bystanders.



WARNING: Fire or explosion hazard. **NEVER** operate this machine in an explosive atmosphere (grain dust, flammable liquids or fumes, etc.).



WARNING: Fire or explosion hazard. **NEVER** attempt to pick up flammable or combustible materials or use such materials in tanks.

WARNING: Orange Oil (D-limonene) is not compatible with the plastics used in NSS automatic scrubbers and the Sidekick Chemical Metering System. Use of D-limonene may result in damage to the machine.

WARNING: This product contains a chemical known to the state of California to cause cancer and birth defects or other reproductive harm.

INTENDED USE

This machine is intended for commercial use, scrubbing floors in an indoor environment. NSS does not recommend using these machines for any other purpose.

FOR SAFETY

- **ALWAYS** read and understand all instructions before operating or servicing machine.
- **ALWAYS** use this machine **ONLY** as described in this manual.
- **NEVER** attempt to operate this machine unless you have been trained in its operation.
- **NEVER** allow an untrained person to operate this machine.
- **NEVER** attempt to operate this machine if it is not working properly or has been damaged in any manner.
- **NEVER** disconnect or modify any switches or safety devices (circuit breaker).
- **NEVER** drop or insert any object into any machine opening.
- **NEVER** operate this machine with any air opening blocked. Keep all air openings free of dust, lint, hair, etc.
- **NEVER** pick up anything that is burning or smoking, such as cigarettes, matches or hot ashes.
- **NEVER** spray this machine with water or any liquids.
- **NEVER** allow the vacuum motor or battery charging plug to get wet or a short may occur.
- **NEVER** operate this machine when the battery charger is plugged in.
- **NEVER** operate this machine with the side skirt removed.
- **NEVER** allow this machine to be used as a toy. Close attention is necessary when used by or near children.

- **ALWAYS** wear clean tennis shoes or “non-slip” shoes. Leather soled shoes will be extremely slippery when wet.
- **ALWAYS** keep face, fingers, hair or any other body part or loose clothing away from any machine opening or moving part (revolving brush, pad driver, or vacuum motor).
- **ALWAYS** turn the machine off when attaching pads or brushes.
- **ALWAYS** remove keys when this machine is left unattended.
- **NEVER** turn on machine unless sitting in the operators seat.
- **NEVER** climb on machine when it is turned on.
- **NEVER** use machine to transport passengers other than the operator.
- **ALWAYS** be sure that the ramp is secured to the vehicle before attempting to load / unload.
- **ALWAYS** use extreme caution when operating the machine on a ramp or loading / unloading this machine into or out of a truck / trailer. Use extreme caution if the ramp is wet, oily, or covered with cleaning chemicals.
- **NEVER** stop or turn the machine on a ramp or incline.
- **NEVER** attempt to climb a grade or operate this machine on a ramp or incline of more than 8 degrees.
- **NEVER** park or store the machine near a dock, on ramps, near a furnace, boiler, open flame, or other high heat source.
- **NEVER** allow this machine to freeze.
- **NEVER** expose the machine to rain, snow, or extreme temperatures.
- **NEVER** store any items on the machine.
- **ALWAYS** store this machine indoors in a dry, cool area.

ALL REPAIR SERVICE MUST BE PERFORMED BY AN NSS AUTHORIZED DISTRIBUTOR / SERVICE STATION USING ONLY NSS ORIGINAL EQUIPMENT PARTS.



SAVE THESE INSTRUCTIONS

IMPORTANT SAFETY INSTRUCTIONS

BATTERY POWERED EQUIPMENT WITH ON BOARD CHARGERS



WARNING: Failure to observe these instructions can cause personal injury to machine operator or bystanders.

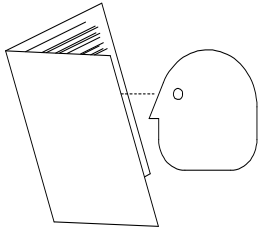

Read and understand all instructions before installing or charging batteries.

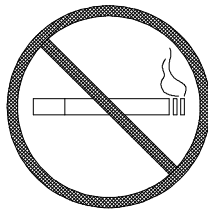

No smoking, open flames, or sparks while working with batteries.

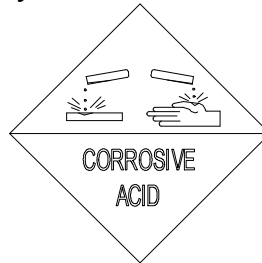

Contains acid. Avoid contact

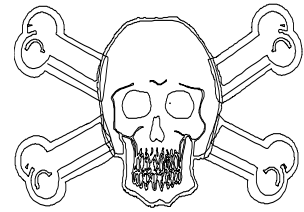

Poison. Causes severe burns. Avoid contact.

WARNING: Batteries emit hydrogen, which can cause fire or explosion.

NEVER smoke, light a match, or cause a spark during operation or charging.

ALWAYS charge in a well-ventilated area away from open flame.

GENERAL

- **ALWAYS** read and understand all instructions before installing or charging batteries.
- **NEVER** attempt to install or charge batteries unless you have been trained to do so.
- **NEVER** allow an untrained person to install or charge batteries.
- **ALWAYS** remove all jewelry when working on or near the batteries.
- **ALWAYS** turn off all switches during installation and service.
- **ALWAYS** disconnect the battery leads before performing any service or repair.
- **ALWAYS** wear eye protection and protective clothing to avoid contact with battery acid.
- **NEVER** lay anything on top of batteries as arcing may occur.
- **IF CONTACT WITH BATTERY ACID OCCURS**, follow these instructions:
 - SKIN – rinse area with water.
 - EYES – Flush with water for 15 minutes.
 - INTERNAL – Drink water or milk. Follow with Milk of Magnesia, beaten egg or vegetable oil. Call a physician immediately.

BATTERY INSTALLATION

- **ALWAYS** use two people to install, as batteries are heavy.
- **ALWAYS** turn off all machine switches.
- **ALWAYS** position batteries as shown on the machine installation decal to maintain machine balance.
- **ALWAYS** connect batteries as shown on the machine installation decal to avoid shorting out the batteries and the electrical system.

BATTERY CHARGING

- **ALWAYS** read instructions on charger carefully.
- **ALWAYS** use the NSS supplied charger with proper voltage rating.

For lead acid batteries only, (does not apply to gel cell or maintenance free batteries).

- **ALWAYS** check to ensure the battery water level covers the battery plates before charging.
- **ALWAYS** check water level after charging and add water if necessary to bring level to the bottom of the fill hole.
- **NEVER** overfill batteries as battery and machine damage may result.
- **ALWAYS** wipe any acid from the top of batteries using a soap solution.
- **ALWAYS** study battery manufacturers' specific precautions such as recommended rates of charge.
- **ALWAYS** reattach caps to batteries. Do not charge with caps loose or removed.
- **ADD** only distilled or treated city water. Not well water.
- **NEVER** charge a frozen battery.
- **ALWAYS** plug the charger into an earthed socket-outlet.
- **NEVER** touch uninsulated portion of output connector or uninsulated battery terminal.
- **ALWAYS** disconnect the AC supply before making or breaking the connections to the battery while charging.
- **NEVER** open or disassemble charger.
- **NEVER** operate charger if the AC supply cord is damaged or if the charger has received a sharp blow, been dropped, or otherwise damaged in any way.

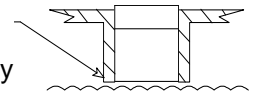

ALL REPAIR SERVICE MUST BE PERFORMED BY AN NSS AUTHORIZED DISTRIBUTOR/ SERVICE STATION USING ONLY NSS ORIGINAL EQUIPMENT PARTS

IMPORTANT SAFETY INSTRUCTIONS



GROUNDING OF ELECTRICAL EQUIPMENT - BATTERY CHARGER

WARNING: Improper connection of the equipment–grounding conductor can result in a risk of electric shock. Check with a qualified electrician or service person if you are in doubt as to whether the outlet is properly grounded. Do not modify the plug provided with the charger – if it will not fit the outlet; have a properly grounded outlet installed by a qualified electrician.

Always use a properly grounded 3-wire extension cord, which has male and female plugs. If 25 foot extension cords are used, the electrical carrying capacity should be no less than 14-3 ST., 50-foot extension cords no less than 12-3 ST.

GROUNDING INSTRUCTIONS

This charger shall be grounded while in use to protect the operator from electric shock. The charger is provided with a three-conductor cord and a three-contact grounding type attachment plug. The plug must be plugged into an appropriate outlet that is properly installed and grounded in accordance with all local codes and ordinances. The green conductor in the cord is the ground wire. Never connect this wire to other than the grounding pin of the attachment plug.

Check nameplate on the charger to be sure **voltage** and **cycle** stated is the same as the electrical outlet. Do not attempt to plug a 120-volt charger into a 240-volt outlet or a 240-volt charger into a 120-volt outlet. If the cord provided with the charger has an attachment plug as shown in Figure A. below, it is intended for use on a nominal 120-volt circuit. If a properly grounded receptacle as shown in Figure A is not available, an adapter may be installed as shown in Figure B if the outlet box that houses the receptacle is grounded. Be sure to fasten the grounding tab (the green colored rigid ear, lug or the like extending from the adapter) with a metal faceplate screw.

If the cord provided with the charger has an attachment plug as shown in Figure C, it is intended for use on a nominal 240-volt circuit (single phase only). No adapter is available for this plug.

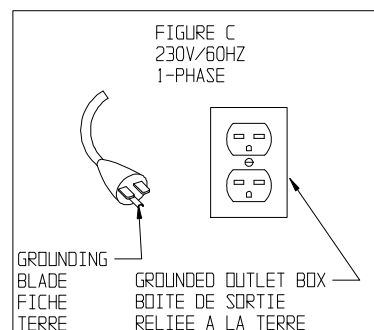
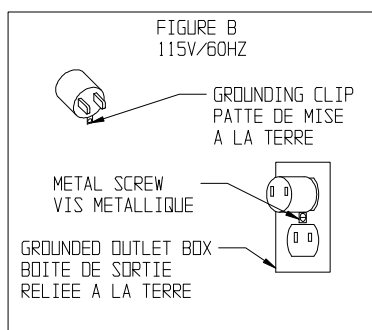
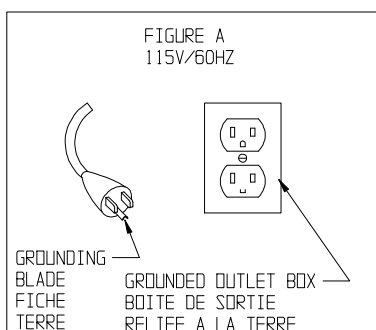

NOTE: In Canada, the use of a temporary adaptor is not permitted by Canadian electrical code.

ALL REPAIR SERVICE MUST BE PERFORMED BY AN NSS AUTHORIZED DISTRIBUTOR/ SERVICE STATION USING ONLY NSS ORIGINAL EQUIPMENT PARTS.

SAVE THESE INSTRUCTIONS



NOISE AND VIBRATION

NOISE

Sound pressure level at Operator position 70 dB(A)

VIBRATION

Weighted RMS acceleration value (ISO 5349) .407 m/s²

MACHINE INSPECTION

- Now that the machine is unpacked remember to recycle all packing materials.
- Inspect the machine for damage or missing components. If damage is found, contact the local freight company to file a freight claim.
- Inspect squeegee assembly for concealed damage.

MACHINE COMPONENTS

CONTROL PANEL

The operator control panel is located to the left of the operator's seat. This panel has components that control various machine functions. See diagram below.

Key Switch - key must be turned to the right to activate machine.

Brush Switch - 3 positions, 3 functions:

- Up is on, lowering brushes to light pressure.
- Middle is off, raising brushes.
- Down is on, lowering brushes to heavy pressure.
- Brushes only come on when machine is moving in forward or reverse.

LCD Display Screen - Displays battery condition, machine function, and error codes, it is brightly lit to work in all lighting situations.

Traction Speed Switch - 3 Positions:

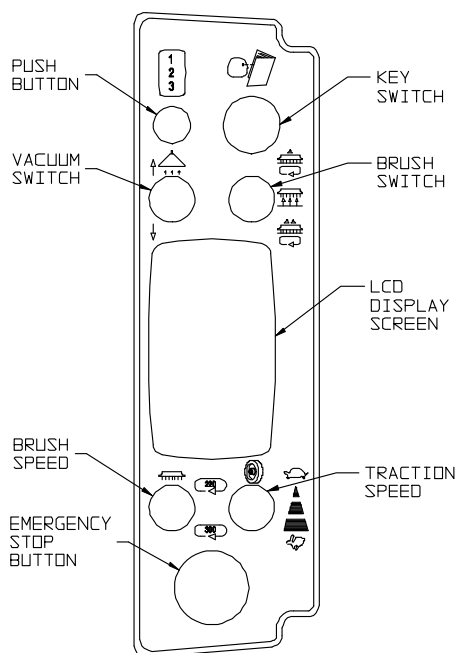

- Down is high speed.
- Center is medium speed.
- Up is low speed. **Push Button** - Toggles between display screens. Defaults to screen 1 when turned on.

Vacuum Switch - 2 positions; 2 functions:

- Up is on, lowering squeegee.
- Down is off, raising squeegee.
- Squeegee automatically rises in reverse.

Brush Speed – 2 positions

- Up rotates the brushes at 220 RPM.
- Down rotates the brushes at 300 RPM.

Emergency Stop Button

- Push for off.
- Turn for on.

Tilt Steering Column Knob

- Adjust the angle of tilt

Foot Pedal Knob

- Controls variable speed forward and reverse.

Sidekick Chemical Dispensing (optional)

- Controls for chemical dispensing are located on the Pump Control Panel.

THE DISPLAY SCREENS

There are many symbols that can be displayed on the LCD. Therefore, the LCD Push Button can be used to toggle between pre-defined screens (see Control Panel for Details).

Screen 1

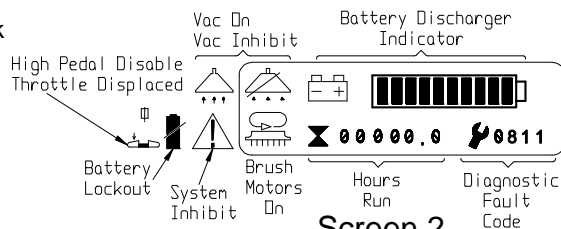

Screen 2

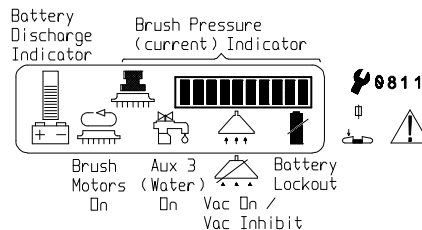

Screen 3

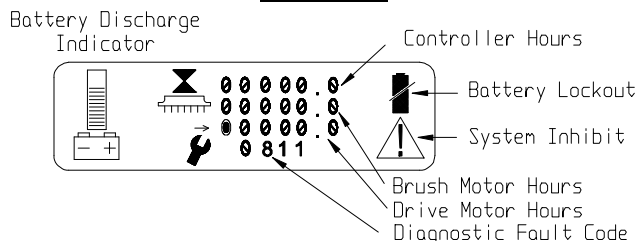

MACHINE OPERATION

General Information

The CHAMP 3529 is very maneuverable and is designed to clean as you drive the machine. Follow these steps to prepare the machine for daily operation.

- **Always** sweep or dust mop the floor of debris before scrubbing. You may also need to **preclean** some types of spills or stains before scrubbing.
- Plan your work so that you make long, straight paths with the fewest amount of turns as possible.
- Remove as many obstacles as possible from the area to be cleaned.
- Place “Wet Floor” warning signs in area being cleaned.
- Consult your local NSS distributor for more complete procedures and chemical advice.

Preparing the Machine for use

Prepare the Solution Tank:

- Never use water over 140° F (60° C).
- Pour all liquids through the mesh filter at the left side of the solution tank.
- Fill with clean water, up to 29 gallons.
- Add the cleaning chemicals to the solution tank.

Prepare the Recovery Tank:

- Always use a defoamer to protect the vacuum motor of this machine. We recommend that you add at least 4 to 6 ounces of defoamer chemical.
- Vacuum the defoamer into the recovery tank through the vac hose.
- Make sure that the drain plug of the recovery tank hose is closed tightly.

Install a Pad Driver and Pad:

- There is a wide range of pads or brushes available for the many cleaning applications of this machine. See the “Accessories” page in the Parts List manual.
- Pull pin and open skirt.
- Turn the pad driver upside down on the floor and remove the pad holding cup.
- Remove the center cutout of the 17” pad and place the pad on the face of the pad driver.
- The pad *must be centered* on the driver to prevent wobbling or bouncing.
- Install and secure the pad holding cup to the pad driver. Turn the pad driver over so that the pad faces the floor.
- Raise the brush motor into the transport position (center position of switch).
- Align the lugs of the pad driver with notches of the drive casting.
- Turn the pad driver to lock onto the drive casting.
- Close the locking latch.
- Close the skirt.
- Repeat for the other side.

Install a Brush:

- Pull pin and open skirt.
- Raise the brush motor into the transport position.
- Align the lugs of the brush with the notches of the drive casting.
- Turn the brush to lock onto the drive casting.
- Close the locking latch.

- Close the skirt.

Install the Squeegee Assembly:

- Loosen the two mounting knobs and slide the squeegee assembly onto the mounting plate.
- Hand-tighten the mounting knobs. Do **not** use pliers to tighten the knobs, as this will defeat the “breakaway” design.
- As the machine is used, the squeegee blades wear out, and need to be replaced due to damage.
- Squeegee blades should lie over (like a window squeegee) whenever the machine is moving forward.
- Do not add any weights or other pressure to the squeegee mechanism; it will not improve the performance or service life.
- The squeegee rises automatically when the machine is in reverse.
- Squeegee springs add pressure to floor. There are 3 adjustments available by moving the end of the spring closest to the frame from hole to hole. More pressure is added the further away the hole is from the center point. When changing the pressure always move **both** sides, using the same distance (hole) on each side.
- It is recommended that, with new blades, the rear wheels be adjusted to their lowest position. Loosen the two screws on the bracket rotate the bracket downward as far as it will go, then tighten the screws. Perform this adjustment on both wheels/brackets.
- When the squeegee becomes worn, and the wiping edge no longer contacts the floor properly, further use may be possible by adjusting the rear wheels upward enough to restore proper engagement of the blades wiping edge with the floor. Be sure to adjust the wheels back down fully when a new blade is installed.

NOTE: Remove squeegee, brushes or pad drivers, and side skirts if transporting to different places or loading / unloading into a truck or trailer.

Install the batteries:

- Turn off all switches and tilt the battery compartment lid open to expose battery compartment.
- Batteries are heavy - use two people to install.
- Refer to wiring diagram inside the battery compartment. Align batteries in compartment as shown on diagram.
- Install battery cables as shown on wiring diagram.
- Tighten bolts and hex nuts with a wrench.

Caution: Do not touch two terminals with a wrench.

- Loose or improper battery connections will cause battery or machine damage and possible personal injury.

Charge the batteries before use!

Battery Charging

- To recharge the batteries plug the charger cord, located at the rear of the machine, into an electrical outlet (100/115/230 50/60 HZ VAC).

CAUTION: Make sure the battery type LED on the charger matches the type of battery installed in your machine! EXCEPTION-TROJAN AGM'S TO BE CHARGED WITH GEL SETTING.

- When the cord is plugged into an outlet the machine will become disabled.

See Battery Charger section for more details.

Prepare the Sidekick Chemical Metering System (if equipped)

*****CAUTION: Purging the Sidekick lines may dispense a small amount of the chemical directly onto the floor. If using wax stripper or harsh chemicals, purge the lines in an area that cannot be damaged by the chemical in use.**

- Place a container filled with the desired cleaning chemical into the bottle holder located at the front of the machine.
 - The bottle holder accepts F-style rectangular containers, and some smaller round containers.
 - Empty F-style containers are available from NSS, order part #9590171.
- Ensure all hose fittings are tight, then insert the suction tube into the chemical bottle, and tighten the cap.
- Turn on the Scrubber, then press the ON button on the Sidekick. The ON indicator will illuminate.
- Press and hold the PURGE button on the Sidekick until you see the supply line to the pump filled with the chemical.
- Select the desired dilution ratio as recommended by the chemical manufacturer.
- The Sidekick is ready for use.

To Change Chemicals

- Loosen the cap on the chemical bottle, and remove the suction line from the chemical bottle.
- Dispose or store any remaining chemical according to local and federal regulations.
- Place the suction line into a container of clean water.
- With the machine over a floor drain, press and hold the purge button until the clean water is drawn thru the pump and dispensed at the brushes.
- Remove the suction line from the container of clean water. Replace the container of clean water with a container of the desired chemical, and install the suction line.
- Press and hold the Purge button until chemical is seen being drawn up to the pump, and pumping down the tube from the pump to the tee fitting below the machine.
- **After each use, always flush the Sidekick lines with clean water** to prevent dried chemical from accumulating in the lines.

MACHINE MAINTENANCE

Daily Maintenance

- You must recharge the batteries when indicated by the battery meter, and after every use. Read the battery meter while the machine is in use.
 - *325 Ah batteries normally require 14 ½ - 16 ½ hours to fully charge.
- **NEVER** let the batteries sit overnight after the machine has been run for more than 1 hr since last recharge.
- **See Battery Charger section.**

Battery Electrolyte (Liquid) Level (Flooded only)

- Add only water to the cell of a battery (**Flooded only**) to adjust the liquid level. Distilled water preferred, **Do Not** use well water. Before charging, add only enough water to ensure the top of the plates are covered. After charging, add only enough water to bring the level to the bottom of the fill tube.
- **Do not** overfill the battery liquid level, this will cause electrolyte (acid) spill. Spilled electrolyte (acid) can cause machine damage and personal injury. Clean up and dispose of all spills immediately.
- See the battery-warning sheet (page 2) for more details.
- If machine is equipped with battery Auto-Fill system fill batteries prior to charging.
- Empty and rinse clean the recovery tank.
- Remove and rinse clean the squeegee assembly.
 - ***NOTE: prolonged exposure to some wax stripper brands may degrade the squeegee material. Rinsing after use in a wax floor stripping application is highly recommended.
- Remove and rinse clean the pad driver and / or brush.
- Inspect the machine components for wear or damage. Call authorized service center for repairs.
- Wipe machine down; **NEVER** spray this machine with water or any liquids.
- Inspect the squeeze tube in the Sidekick Chemical Metering System for cracks or leaks.

Sidekick Chemical Metering System

- Purge the lines with clean water after each use.
- The squeeze tube under the see-through cover on top of the pump requires periodic replacement approximately every 500 hrs (depending on chemicals used).
- To replace the squeeze tube:
 1. remove ferrule nuts from pump
 2. unscrew pump cover, exposing the squeeze tube.
 3. remove damaged squeeze tube and replace with new squeeze tube.
 4. a screwdriver can be inserted in the spinner hub and rotated as the tube is being replaced to ease insertion. It is important not to twist the tube as it is being inserted and the fittings should be inserted "flat side up"
 5. add grease from the included packet.
 6. Re-install cover and resume normal operation

Weekly Maintenance (Every 20 Hours)

- Verify that all daily maintenance has been performed.
- Inspect the battery liquid level; using only water, adjust to the proper level as needed.
- NOTE: If optional auto fill system is installed, follow the directions that come with this system.
- Check all battery terminal and cable connections. Tighten as deemed necessary.
- Clean any corrosion from the battery terminals and cables.
- Check the solution flow to the pad driver and / or brush. Flush clean the solution tank and hose with a mixture of 8 oz. (250ml.) of white vinegar to 1 gallon (4 liter) of warm water.

- Inspect filters.

******CAUTION******

Inspect and replenish battery water in every cell in every battery weekly. Failure to maintain proper electrolyte level in every cell of every battery will cause premature battery failure, and void the warrantee.

Monthly Maintenance (Every 100 Hours)

- Verify that all daily and weekly maintenance has been performed.
- Equalize your batteries (**Flooded only**). To equalize the batteries, after they have been fully charged, unplug the charger (from the wall outlet), and plug it back in. The charger will skip thru the first few phases of the charge cycle, and run thru the finish phase. This will balance out all the cells in the batteries, and provide maximum battery life. **THIS STEP IS ESPECIALLY IMPORTANT IF YOU PRACTICE OPPORTUNITY CHARGING (see page 8).**
- Clean filters by rinsing with cool, clear water. Dry Completely.

After every 750 Hours of Operation:

- Inspect the drive motor carbon brushes for wear. Replace the brushes when they are 3/8 in. (9mm.) in length.
- Inspect the brush drive motor carbon brushes for wear. Replace the brushes when they are 1/2 in. (13mm.) in length.
- Inspect the vacuum motor carbon brushes for wear. Replace the brushes when they are 7/16 in. (11mm.) in length.

Battery Replacement Notes

- Entire Pack.
 - It is always recommended to replace all batteries in the pack at the same time.
- One or more batteries out of the pack. This is not recommended. Replacing just one or two batteries out of the pack can lead to the following:
 - Overcharging the new, or the remaining original, batteries.
 - Undercharging the new, or remaining original, batteries.
 - Over discharging either the new or the remaining original batteries.
- If you wish to only replace some of the batteries in the pack, follow these steps for best results:
 - Fully charge both the new battery, and the remaining original batteries. (s.g. = 1.265 minimum, use a hydrometer)
 - Use a replacement battery that is close to the same age as the remaining original ones.
 - Do not run the machine as long for about 20 cycles. For example, if you used to get 4 hrs runtime, only run it for 2.5 hrs, and then charge the batteries completely.
 - Opportunity charge whenever possible.
 - Equalize after 30 days. (**Flooded only**)
 - The above steps will provide the best opportunity for the new battery(s) to join the pack.

Battery Charger

The onboard battery charger supplied with this machine is capable of charging lead acid batteries from 185 to 350ah capacity. There is no need to change algorithms or settings based on battery manufacturer, or battery size.

The charger can also be set to charge flooded (wet) cell, AGM, or Gel batteries. LED's on the charger indicate which type of battery the charger is set to charge. One setting is for Flooded and AGM batteries, the other setting is only for GEL batteries.

The charger can operate on 100/115/230 VAC 1ph 50/60 HZ power, and will automatically detect these input voltages.

Determining Your Battery Type

CAUTION: DIFFERENT BATTERY TYPES HAVE DIFFERENT CHARGING REQUIREMENTS. FAILURE TO PROPERLY IDENTIFY YOUR BATTERY TYPE, AND SET THE CHARGER ACCORDINGLY, WILL RESULT IN BATTERY DAMAGE, AND VOID THE WARRANTY.

Your machine may have been ordered with batteries installed at the NSS factory. The standard battery type, normally supplied by NSS, is the Flooded (wet) cell lead acid battery. Gel and AGM sealed batteries may also be available at customer request.

Flooded (wet) batteries can be easily identified by the removable cell caps. Removing the caps allows inspection of the liquid electrolyte (sulfuric acid) level in each cell.

AGM (Absorbed Glass Mat) batteries are sealed, maintenance free batteries. They do not have cell caps intended for removal. Look for "**AGM**" printed on the tops or sides of the batteries.

Gel (gelled electrolyte) batteries are also sealed, maintenance free batteries. They do not have cell caps intended for removal. Look for "**GEL**" printed on the tops or sides of the batteries.

Battery Charger Indicator LED's

Your battery charger is equipped with LEDs that indicate the following:

- Battery Type Setting. Either of these two LEDs will be illuminated, anytime the charger is plugged in, to signal which type(s) of batteries the charger is configured to charge. The two options available are:
 - Wet / AGM: When this LED is illuminated, the charger is configured to charge either flooded (wet), or AGM batteries.
 - Gel Cell. When this LED is illuminated, the charger is configured to charge Gel batteries ONLY. **EXCEPTION: Trojan AGMs are to be charged with the Gel setting.**
- State of Charge Indicators. Four additional LEDs provide information about the charge level of the batteries during charging.

o30%, 60%, 90% and 100%.

- Fault Indications. During charging, the charger provides feedback about the charge process

and any problems detected. It will provide feedback and signal the type of problem by flashing LEDs as described below:

Wet/AGM (Amber)	Gel Cell (Amber)	30 (Red)	60 (Red)	90 (Red)	100 (Green)	Meaning
On	Off					Charger is set for Wet/AGM batteries.
Off	On					Charger is set for Gel batteries.
One light on*		On	Off	Off	Off	Charger cycle is in process - bulk stage
One light on*		On	On	Off	Off	Charger cycle is in process - bulk stage
One light on*		On	On	On	Off	Charger cycle is in process - absorption stage
One light flashing*		Off	Off	Off	Flashing	Charger nearing the end of the charge cycle.
One light on*		Off	Off	Off	On	Charge cycle is complete.
One light on*		Flashing	Off	Off	Flashing	Damaged battery detected. One or more batteries failed to complete the charge cycle. Check battery water levels. Batteries can be used, but will not provide full run time.
One light on**		Flashing	Off	Off	Off	No batteries detected. Check that the battery pack is plugged into the machine. Check wiring.
One light on*		Flashing	Flashing	Off	Off	Batteries failed to climb above 1.74 volts per cell within the first three hours of charging. The batteries are damaged and will need to be replaced.
One light on*		Off	Flashing	Flashing	Off	Charge cycle time out. The charge cycle did not finish in the allowed time. Check the battery water levels. Unplug the charger and plug it back in. Allow the batteries to charge again. If the code is repeated, then it is likely that the batteries are damaged.
One light on*		Flashing	Flashing	Flashing	Off	Charge cycle time out. The charge cycle did not finish in the allowed time. Check the battery water levels. Unplug the charger and plug it back in. Allow the batteries to charge again. If the code is repeated, then it is likely that the batteries are damaged.
One light on*		On	Off	On	Off	Internal over temperature. The charger's internal temperature exceeded the maximum permitted. If possible, move the machine to a cooler location. Unplug the charger and plug it back in. Allow the batteries to charge again.

* The light that is on depends on the charger configuration (Wet/AGM or Gel Cell)

** The light (Wet/AGM or Gel Cell) will only stay on for two seconds

Changing the Battery Type Setting

The standard setting for the onboard battery charger is Flooded/AGM. EXCEPTION: If your machine was ordered from NSS equipped with Gel batteries, then the charger was configured for Gel batteries at the factory.

Configuring the Charger for Gel batteries.

- 1.Remove the top cover.

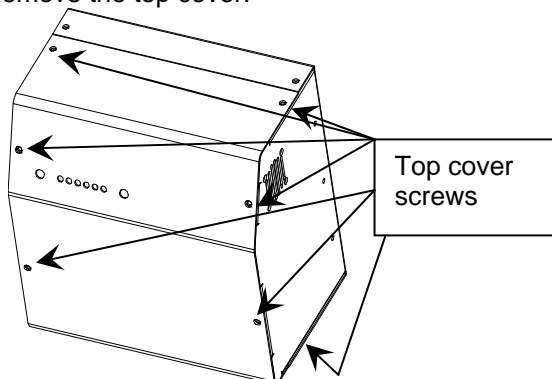

- 2.Pull the jumper off the board (position 1), and then store the jumper for later use at position 2. See photo below.

- 3.Reinstall the top cover.

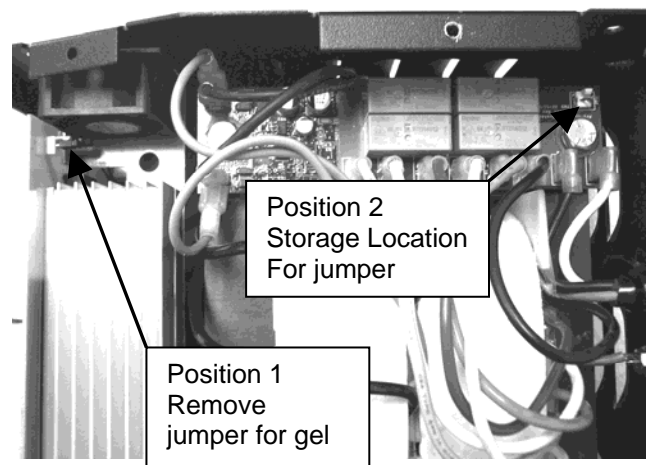

Configure the Charger for Flooded/AGM batteries

- 1.Remove the top cover
- 2.Pull the jumper from the storage location (position 2), and install the jumper at position 1.
- 3.Reinstall the top cover.

Operating the Battery Charger

CAUTION: DIFFERENT BATTERY TYPES HAVE DIFFERENT CHARGING REQUIREMENTS. FAILURE TO PROPERLY IDENTIFY YOUR BATTERY TYPE, AND SET THE CHARGER ACCORDINGLY, WILL RESULT IN BATTERY DAMAGE, AND VOID THE WARRANTY.

The battery charger is fully automatic. Simply plug the charger into a suitable wall outlet, and the charger will charge the batteries. The green 100% LED will be continuously illuminated when the charge cycle is complete.

A bubbling, or boiling sound coming from the batteries during the last few hours of the charge is normal. The batteries may be warm, but not too hot to touch.

Equalizing the batteries (Flooded only)

The batteries should be equalized once every 30 days to ensure maximum battery life.

To equalize the batteries:

- Plug in the charger, and fully charge the batteries (until the green 100% LED is on continuously).
- Unplug the charger from the wall outlet, then plug it back in.
- The charger will run for 2.5hrs, holding the batteries at a constant voltage, and equalizing each cell.

Battery Do's and Don'ts:

- a. You do not have to fully discharge the batteries before charging. They do not have a "memory".
- b. Plug the charger in anytime the machine is not in use.
- c. NEVER let the electrolyte level fall below the tops of the plates (flooded cell batteries). This will damage your batteries almost immediately, and void the battery warranty. It will be evident if this has happened.
- d. NEVER refill the batteries with well water (flooded cell batteries).
- e. NEVER overfill the batteries (flooded cell batteries).
- f. NEVER let the batteries sit discharged overnight (or between shifts).
- g. ALWAYS check the electrolyte level about every 3 or 4 charge/discharge cycles BEFORE CHARGING.
- h. ALWAYS refill the batteries (if needed) AFTER
 -

CHARGING.

- i. ALWAYS fully recharge the batteries after use (until the green LED comes on).
- j. ALWAYS equalize the batteries every 30 days **(Flooded only)**.
- k. NEVER OVER DISCHARGE!
- l. NEVER charge GEL batteries with the charger set to FLOODED/AGM.
- m. NEVER charge FLOODED/AGM batteries with the charger set to GEL. **EXCEPTION-TROJAN AGM'S TO BE CHARGED WITH GEL SETTING.**

Opportunity charging is recommended, as this extra charging time will help raise the operating voltage of the batteries, and will help ensure maximum cycle life.

**TABLE 1
Battery Types**

NSS Part Number	Crown Part Number	Battery Volts	System Volts	Amp Hour	Battery Type Setting
4491061	1-1470	12	36	210	Flooded/AGM
3390361	1-1435	6	24 & 36	225	Flooded/AGM
2392111	1-1427	12	24	115	SPE CURVE 0
6393651	1-1428	12	24	145	SPE CURVE 0
2392731	1-12145	12	24	100	SPE CURVE 1
6491931	1-1437	6	24 & 36	200	Gel
2691501	1-1450	6	36	325	Flooded/AGM

Opportunity Charging

Opportunity charging is charging the batteries when an opportunity presents itself, such as during breaks, and is done **in addition to a full charge cycle**.

NOTE: Trojan AGM batteries should be charged with the GEL setting.

**The charger has been tested on batteries from the following manufacturers:

- Crown flooded cell
- Trojan flooded cell
- US Battery flooded cell
- Deka flooded cell
- Crown gel
- Concord gel
- Discover AGM

TRIO+: Scrubber System Diagnostic Codes

Scrubber System Faults External to TRIO+

Code	Fault Description	Corrective Action
0810	Throttle fault-1.0	For all Throttle Diagnostic Codes:
0811	Throttle max wiper difference error.	1- Check the throttle wiring for shorts or opens. Repair or replace as necessary.
0812	Throttle max pull down difference error.	2- If Diagnostic Code is not cleared, then replace throttle (Potentiometer).
0813	Throttle max pull safe difference error.	" " " "
0814	Throttle reference error.	" " " "
0815	Throttle lo reference error.	" " " "
0816	Throttle hi reference iso error.	" " " "
0817	Throttle lo reference iso error.	" " " "
0818	Throttle error both have readings.	" " " "
1310	Excessive current trip.	High Voltage - Battery Voltage exceeds Controller Parameters.
1311	Soft aux 1 over current occurred.	Brush Lift Actuator exceeded current limit. Check limit switch settings, wiring, or replace.
1312	Soft aux 2 over current occurred.	Squeegee Lift Actuator exceeded current limit. Check limit switch settings, wiring, or replace.
1313	Soft aux 3 over current occurred.	Solution Solenoid exceeded current limit. Check wiring, or replace.
1314	Soft aux 4 over current occurred.	Overhead Light or Head Light exceeded current limit. Check wiring (diodes), or replace device.
1318	Soft brake light over current occurred.	Horn circuit exceeded current limit. Check wiring (diodes) or replace device.
131C	Soft alarm over current occurred.	Beeper circuit exceeded current limit. Check wiring or replace device.
1321	Aux 1 over current 2 occurred.	Brush Lift Actuator exceeded current limit. Check limit switch settings, wiring, or replace.
1322	Aux 2 over current 2 occurred.	Vac Lift Actuator exceeded current limit. Check limit switch settings, wiring, or replace.
1411	Error aux 1 positive shorted - low.	Check Brush Lift Actuator and wiring. Repair or replace as necessary.
1412	Error aux 1 negative shorted - low.	Check Brush Lift Actuator and wiring. Repair or replace as necessary.
1413	Error aux 2 positive shorted - low.	Check Squeegee Lift Actuator and wiring. Repair or replace as necessary.
1414	Error aux 2 negative shorted - low.	Check Squeegee Lift Actuator and wiring. Repair or replace as necessary.
1501	Brake fault 2.	Check Brake circuit wiring and brake. Repair or replace as necessary.
1507	Brake over current error.	Check Brake circuit wiring and brake. Repair or replace as necessary.
1600	High battery error.	Battery is overcharged or damaged. Replace battery.
1D02	Front-end spec change trip.	Drive parameters have been reprogrammed. Cycle power with key switch.
1E03	Inhibit activated.	Fix whatever condition is causing Inhibit signal.
1E04	Inhibit activated 2.	Fix whatever condition is causing Inhibit signal.
1E06	Inhibit input out of range.	Invalid Inhibit signal. Check wiring and device. Repair or replace as necessary.
2C00	Low battery error.	Battery Charge too low. Recharge battery.
2C01	Low battery error 2.	Battery Charge too low. Recharge battery.

2C02	Soft battery lockout occurred.	Battery Charge too low. Recharge battery.
2C03	Soft battery lockout 2 occurred.	Battery Charge too low. Recharge battery.
2F01	Tiller displaced error.	Throttle displaced on Power-up. Release throttle and then re-engage throttle. Check Potentiometer settings (neutral).
3A00	Bad settings.	Illegal program parameter settings.
7000	Startup with push selected.	N/A
7001	Push activated in drive mode.	N/A
7500	Tiller comms timeout.	Problem with LCD Module or wiring. Check cable connection between controller and LCD. Repair or replace as necessary.
7600	Soft brush motor disconnected error.	Check Brush Motor wiring and connections.
7601	Soft brush current fold back.	Check Brush Motor for excessive amp draw. Check for locked rotor conditions (debris caught in brushes, gear box locked up, etc.). Repair or Replace as necessary.
7602	Soft brush current fold back 2.	Check Brush Motor for excessive amp draw. Check for locked rotor conditions (debris caught in brushes, gear box locked up, etc.). Repair or Replace as necessary.
7603	Soft brush current fold back 3.	Check Brush Motor for excessive amp draw. Check for locked rotor conditions (debris caught in brushes, gear box locked up, etc.). Repair or Replace as necessary.
7604	Soft brush inhibit.	Check Brush Motor for excessive amp draw when starting. Repair or Replace as necessary.
7605	Brush startup over current detection.	Check Brush Motor for excessive amp draw. Check for locked rotor conditions (debris caught in brushes, gear box locked up, etc.). Repair or Replace as necessary.
7700	Soft vacuum motor disconnected error	Check Vac Motor wiring, connections and carbon brushes.
7701	Soft vacuum current fold back.	Check Vac Motor for excessive amp draw. Repair or Replace as necessary.
7702	Soft vacuum current fold back 2.	Check Vac Motor for excessive amp draw. Repair or Replace as necessary.
7703	Soft vacuum current fold back 3.	Check Vac Motor for excessive amp draw. Repair or Replace as necessary.
7800	Traction motor fault -1.	Check Drive Motor wiring, connections.
7801	Traction motor over current error.	Check Drive Motor for excessive amp draw. Release Parking Break. Replace as necessary.
7802	Soft traction motor in fold back state.	Traction Motor being overloaded or Fold back parameters set too low.
7803	Motor line voltages instability timeout.	Check Drive Motor wiring, Controller wiring, connections.
7880	Traction speed input out of range.	Check Drive Motor wiring, Controller wiring, connections.
7900	Emergency stop error.	N/A
7901	Soft belly button activated.	N/A
8000	Service mode.	N/A
9000	Brushes not fitted.	N/A

Possible Internal TRIO+ Faults

Code	Code	Code	Code	Corrective Action
0003	1800	3104	3603	For All Internal TRIO + Diagnostic Codes:
0100	1802	3105	3608	1 - Turn Off Key switch and disconnect batteries.
0204	1B20	3200	3609	2 - Wait 1 minute.
0705	1B21	3201	360a	3 - Reconnect Batteries and turn On Key switch.
0706	2102	3210	360b	4 - If Diagnostic Code is not cleared, then replace TRIO+.
0A01	2103	3211	360c	
0B02	2D01	3212	360d	
0B0B	3100	3213	360e	
1704	3101	3214	7501	
1705	3102	3601		
1706	3103	3602		

TROUBLE SHOOTING – SIDEKICK CHEMICAL DISPENSOR

PROBLEM	CAUSE	SOLUTION
Sidekick pump not operating	Turned off, water valve is off, brushes turned off	Ensure pump, solution valve, and brushes are on.
	Improper wiring	Inspect/repair by qualified technician
	Sensor plugged	Remove sensor and blow air (5psi max) thru in the opposite direction as the arrow on the part to clear the obstruction.
Sidekick operating, but not pumping chemical	Vacuum leak at fittings on bottle cap, Squeeze tube cracked, chemical bottle empty	Check fittings at bottle cap for leaks. Replace squeeze tube if cracked. Fill chemical bottle.

TROUBLE SHOOTING

PROBLEM	CAUSE	SOLUTION
No Solution Flow.	The solution valve is closed.	Open the solution valve.
	Water solenoid valve not open.	Charge the battery.
	Obstruction in the solution hose.	Remove the obstruction.
	Solution valve or cable damaged.	Repair / replace the valve cable.
	Solution tank is empty.	Fill the tank.
	Solution valve is dirty.	Clean the solution valve.
	Damaged seat and washer in valve.	Replace valve.
Will Not Pick Up Any Water From The Floor.	Squeegee is up.	Lower squeegee.
	Vac motor switch is "off".	Turn vac motor switch "on".
	Recovery tank is full.	Empty tank.
	Vacuum shut-off float is stuck.	Remove obstruction.
	Hole in squeegee hose.	Replace hose.
	Vac motor is not running.	Have an authorized serviceman repair.
	Drain plug not in tight.	Tighten drain plug.
	Porthole cover is missing.	Replace porthole cover.
	Squeegee blade is worn / damaged.	Reverse / replace squeegee blade.
	Obstruction / damage in the squeegee, squeegee hose or standpipe.	Remove obstruction / repair damage.
Batteries Do Not Seem To Run Long Enough.	Tops of batteries are dirty / wet.	Clean / dry, & clean terminals.
	Battery terminals are dirty / damaged.	Clean terminals, and connectors, replace damaged cables.
	Electrolyte level is too low.	Add water and charge.
	Batteries are not fully charged.	Charge batteries until the green LED stays on.
	Charger is damaged.	Have an authorized serviceman repair.
	Battery is defective.	Check SG's after discharging and then after charging.
	Wrong size battery.	Replace with larger batteries.
	Battery tray full.	Drain battery tray.
Cleaning Is Not Even.	Brush / pads are worn.	Replace.
	Damage to brush assembly or solution valve.	Have an authorized serviceman repair.
	Motor is not running.	Check circuit breakers. Reset if necessary, replace carbon brushes, repair wiring, replace switch.
	Not enough or uneven water.	Check solution hose for blockage.
Machine Does Not Run.	Check circuit breaker.	Reset circuit breaker. Check battery connections.
	Code on control panel.	Contact authorized repair service center.
<p>NOTE: If problems remain after taking the above steps, contact your local authorized service station for further evaluation and repair.</p>		

NOTES

NOTES

NOTES



NSS® Enterprises, Inc.

3115 Frenchmens Road, Toledo, Ohio 43607
PHONE (419) 531-2121 FAX (419) 531-3761

NSS® Enterprises, Inc. European Distribution Centre
Unit II, Pinfold Trading Estate * 55 Nottingham Road
STAPLEFORD, NOTTINGHAM NG9 8AD ENGLAND U.K.
PHONE: (44) 0115 939 1568 * FAX: (44) 0115 949 0615